

LINKS

FREE

Volume 20, Issue 15

"The Little Green Paper"

August 05, 2019

Community Links
Linking communities
Increasing knowledge
Expanding horizons
Offering opportunities.

Custom Printing:

Letterhead
Business Cards
Envelopes
Business Forms
Carbonless Forms
Note Pads
Office Supplies
Color Printing
Laminating

Vinyl

Signs, Banners, and License
Plates, Custom T-shirts, caps,
buttons and more!

**Printed and distributed bi-
monthly by persons with
disabilities.**

Editors:

Zia Partovi
Grace Peterson

Data Masters & Sales

Steven Burdick
Bobby Callison
Karen Deffenbaugh
Nikki Hamilton
Eric Peachey
Doug Stone
Breanna McDowell
Stephanie Baker
Heather Conn

Public Relations

Debbie Gray
Alanna Victor
Samantha Peterson

**Assembled at Midco Inc.
Little Green Shop &
Community Links in Chelsea**

Community Links
P.O. Box 85
Chelsea, OK. 74016
1100 Walnut in Chelsea
Phone 918-789-2862
Fax: 918-789-5296
communitylinks1999@
yahoo.com

The First of August and how it came to be Switzerland's National Day

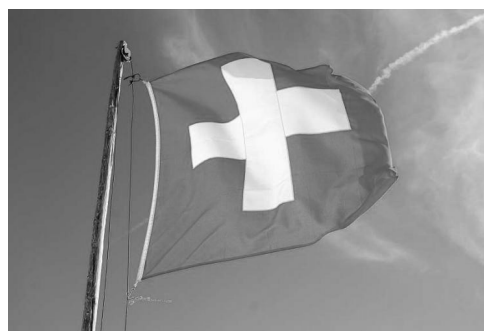

What exactly is being celebrated?

The date is inspired by the date of the Federal Charter of 1291, Pacte du Rütli, placed in "early August", when "three Alpine cantons swore the oath of confederation" (Schwyz, Uri and Unterwald), an action which later came to be regarded as the founding of Switzerland." The document is one of several dozen pacts attested for the territory of Switzerland in the period of the mid-13th to mid-14th century. The foundation of the Old Swiss Confederacy had been mostly associated with the Bund of Brunnen of 1315, or with the Rütli Schwur, dated to 1307 by Aegidius Tschudi.

The Federal Charter of 1291 first assumed great importance in a report by the Federal Department of Home Affairs of 21 November 1889, suggest-

ing a celebration in Bern in 1891 that would combine the city's 700th anniversary with the Confederacy's 600th anniversary.

The date of the Federal Charter came to replace the formerly more prominent, traditional date of 8 November Rütli Schwur, 1307 in popular consciousness in the 20th century, specifically after the 650th anniversary celebrations of 1941.

It has been an official holiday since 1994, following the acceptance of a federal popular initiative in its favour in 1993.

1 August is celebrated each year with paper lantern parades, bonfires, hanging strings of Swiss flags, fireworks and competitive rifle shooting matches.

Town-specific celebrations

The day of independence is typically

celebrated at a local municipality level, though certain events draw nationwide attention. Since the mid-19th century, Schaffhausen has illuminated the nearby 25-meter-high Rhine Falls for special events. Beginning in 1920, the waterfall has been regularly lit for the national holiday and since 1966 is now lit only for this holiday. At the historic location of Rütli Meadow above Lake Lucerne, a representational celebration is staged in the location where the legendary pledge of alliance, the Rütlichwur is said to have taken place. In Basel there are fireworks at the Rhine on the evening of 31 July.

Who celebrates the occasion?

August 1 is a statutory holiday and a work-free day, thus enabling everyone to celebrate as and how they wish.

Customs and Traditions

On Swiss National Day, many people decorate their houses with Swiss flags, and numerous public buildings and streets are also adorned with bunting.

Official festivities have been held every year on the Rütli meadow – where, according to legend, the pledge of allegiance was pronounced and the Swiss Confederation was founded – since 1942. The official address is held by the Swiss President and is broadcast on the TV and radio.

In many municipalities, special brunches or evening festivities take place, often together with a fireworks display, which is held as soon as it gets dark.

In numerous mountainous regions of Switzerland, private persons or societies set fire to huge bonfires in elevated locations, which can be seen from a long distance away.

At 8.00pm, all the church bells in Switzerland ring out for a quarter of an hour.

How does Zurich celebrate the First of August?

There are celebrations in communities all around Switzerland. In most cases, the official ceremonies include a prayer and the singing of the Swiss national anthem (the Schweizerpsalm). At 8:00 p.m. (20:00) church bells ring throughout the country.

Public Life

The Bundesfeier is a public holiday in all of Switzerland. Offices, banks, schools and businesses are closed. Public transport runs on a reduced schedule.

DATA MASTER: Heather Conn

The Business Man

My wife was homeless as a teenager.

On Friday afternoons, a "business man" would walk up to her and ask her if she was hungry. She would say yes, and he would take her into the restaurant on the corner. She never felt any danger with him (and she has had to cut somebody badly before). He was just some dude offering her a meal.

He would let her get anything in the menu. He would sit and read the paper and drink a cup of coffee. There was never any conversation. When he was finished, he would pay the bill and leave. There was never any exchange of words other than "You hungry?" and "have what you want", and "have a good afternoon".

This happened multiple times. She never felt like a project to him. She never felt less than him. She never felt in danger. He was just a guy who saw a dirty girl on the street who needed to eat.

She has since gotten her GED, graduated from a trade school with a fitness degree, and now has earned her MBA with honors. She is an amazing woman and an amazing mother. The one wish she has is that she can run into the "business man" who bought her lunches and thank him.

DATA MASTER: Nikki Hamilton

**L & S Feed
and
Western Wear**

918-476-7234

**102 W Railroad St.
Chouteau, OK 74337**

Dog Rescue On Interstate Freeway In Vancouver, WA

On July 5th my little dog Milo escaped the fenced yard of a friend in Vancouver and ran off.

We suspect he heard day after the 4th fireworks. He ran for miles all the way to the I-5 northbound freeway ramp and was running in and out of traffic on the freeway. A young couple spent several hours chasing him down by car and on foot, rescued him and called me after noting my phone number on his collar. They waited for me in a grocery store parking lot until I came to pick him up.

If it hadn't been for them, he surely would have been killed on the freeway.

Their kindness will never be forgotten!

DATA MASTER: Nikki Hamilton

O & M Sales and Services

DeWalt Milwaukee Paslode Max Makita
Bostitch Stanley Wilton Vaughan Freud
Gun Nails Screws

918-476-7696

305 N. Chouteau ave. Chouteau OK 74337

Chelsea Tag Office

336 W. 6th * Chelsea, OK.

789-2332

Open Monday thru Friday
9am to 12pm 1pm to 5pm
and 9am to 12 pm Saturday
Marie White Agent

A Special Beauty

I was 17 years old. Along with a dozen other boys I had made a long trip to Iowa in order to see a college that I was thinking of attending. While the trip had been fun for the most part, now that I was there I was feeling depressed, alone, and isolated. I was missing my family and was realizing that I wouldn't be seeing them very much if I went to school here. I was also missing the Appalachian mountains of my home. I loved walking in their forests of Maple, Oak, Beech, Birch, and Hickory trees. I loved how the leaves turned a thousand shades of green in the Spring and then became an sea of red, gold, and orange in the Fall. I loved the smell of the Clover and countless wild flowers that grew in our meadows. These things were a part of me.

Here in Iowa everything was flat. The grass looked burnt and brown. All that I could smell was a mixture of corn, mud, and pigs. I walked outside the dormitory of the college and sat on an old stump. I closed my eyes and dreamed of being back home again. When I finally opened them, however, I saw something that touched my soul. It was a Prairie Sunset. It seemed to fill the sky from horizon to horizon. Gold, red, purple and pink clouds all flowed together in a picture painted by Heaven's own hand. It was so huge that it took my breath away. It made our mountain sunsets seem tiny by comparison. I was filled with wonder and felt a special Oneness with God. I realized too that I had been foolish and judgmental. This place too had its own special beauty. This place too was a part of God's Creation.

Over the years to come I learned something else. Each of us has a special beauty as well. Each of us has our own unique talents and abilities. Each of us has a beautiful, powerful love that only we can share. And God wants us to share it. May you always do so then. May your life always shine bright. And may your love glow from your soul like a sunset on the Prairie.

DATA MASTER: Nikki Hamilton

CHELSEA



FAMILY PHARMACY
THE PHARMACY THAT CARES

600 Walnut * Chelsea
918-789-2241

Email: chelseafp@sbcglobal.net
www.chelseafamilypharmacy.com
Joe Forcum, D. PH
Wendy Forcum

Guy Dressed as Batman Has Rescued Dozens of Shelter Pets From Euthanasia



Not all heroes wear capes, but this guy has already saved dozens of dogs and cats from euthanasia – and he has done it all while dressed as Batman.

27-year-old Chris Van Dorn has always been a fan of the beloved Caped Crusader; so when he began volunteering for various animal rescue organizations around Orlando, Florida, he decided to combine his two passions and use a Batman suit to bring attention to the importance of pet adoption.

“It kind of just came as a way to embody all the good I wanted to do in the world,” Van Dorn told The Dodo, “and make it easy for people to talk to me right off the bat.”



Not only has he used the suit as a conversation starter for why people should adopt shelter pets, he has also donned the suit to transport dozens of animals from the shelter to their loving forever homes.

Initially, Van Dorn used the superhero costume as a means of keeping all of his rescue missions anonymous – but his good deeds finally brought his real identity into the limelight after he was featured as an honorary GoFundMe Hero in May.

WATCH: Dog That Shoplifted a Book on ‘Abandonment’ is Given the Love It Was Asking For

Since Van Dorn launched his nonprofit Batman4Paws

in 2018, he has embarked on dozens of hours-long cross-country road trips to rescue dogs from euthanasia and bring them to loving families that are willing to adopt them.

Thankfully, the GoFundMe article helped to finance Van Dorn’s rescue missions since his crowdfunding page has collectively raised about \$32,000 over the course of the last 10 months.



“When I was first starting out, I was keeping everything really anonymous,” Van Dorn told the news outlet. “I would sign everything ‘Bruce Wayne’ and not put my real name out there ... My catchphrase is, ‘It’s not who I am underneath but what I do that defines me’ and I still hold that true today.”

Van Dorn now hopes that he will be able to find a compassionate citizen to donate a bigger van so he can replace his current Batmobile – a humble Honda Accord – and transport more animals on his rescue missions.

CHECK OUT: ‘Walking Dead’ Star Gives Happy Ending to Emu and Donkey That Refused to Be Separated

He also aims to use his pilot’s license as a means of using air travel as a more efficient means of transporting his doggos in distress.

Additionally, since he recently got his trusty sidekick Mr. Boots licensed as a therapy dog, the two have been making plenty of guest appearances as Batman and Robin at various hospitals around Florida.

The Dynamic Duo has also donned their costumes for adoption events and animal shelter fundraisers.

Van Dorn says that the costume helps to draw in more visitors, and he takes every opportunity to hand out brochures and stickers concerning the importance of adoption.

If you would like to learn more about Van Dorn’s mission or make a donation to his nonprofit, you can visit the Batman4Paws website.

DATA MASTER: Doug WM Stone

Consignments
Clothing



And
More

Country Heaven Consignments
Owner Gaila 918-864-9485
104 S. Chouteau Ave.
Chouteau, OK 74337

(918) 785 - 2520

•Cowhide Corner•

101 N Mayes
Adair Oklahoma 74330

Larry & Patsy Eby
Owner

Foreman's Body Shop

ROBERT FOREMAN
Owner

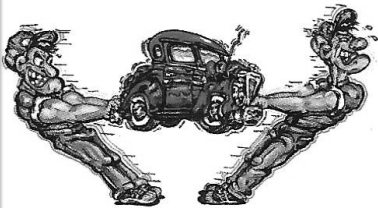

Phone (918) 256-3472
FAX # (918) 256-2796

26853 South 4380 Road
Vinita, OK 74301

WE TAKE THE DENT'S OUT OF ACCIDENTS

RJ's Bar & Grill

918-323-0122

Hours

Mon - Sat 11--2

Sun 2-12

215 E Canadian

Vinita, OK

German 12-Year-old Boy Plants 1 Million Trees, Takes Over UN Program to Plant a Trillion More



The world is a lot greener thanks to this 20-year-old and his army of “climate ambassadors” who have pledged to plant trees and use youth power to avert climate change.

Ever since he was 9 years old, Felix Finkbeiner has been an international figurehead for saving the planet. In 2007, the German youngster founded a global youth movement called “Plant for the Planet” – an initiative that trains and recruits kids from around the world to plant trees as a means of combatting climate change.

Since its creation, the movement has already made significant progress with the help of over 100,000 enthusiastic youth between the ages of 9 and 12—and he planted his one-millionth tree in Germany when he was just twelve. Alongside the Paris Agreement, Finkbeiner’s campaign is a formidable defense of the planet.

His speeches as a pre-teen to the European Parliament and the United Nations General Assembly inspired kids from over 90 countries to join his coalition, saying “Forests are not only the livelihood of billions, but for us children forests are our future.”

The UN then handed over to Felix the leadership of its Billion Tree Program, which was inspired by the Kenyan Nobel Peace Prize-winning activist Wangari Maathai, whose Green Belt Movement planted 30 million trees in Africa. He is enlarging the program, transforming it into a Trillion Tree Campaign: an audacious international grassroots effort to do exactly that – plant one trillion trees in the next 30 years.

LOOK: Remember the Young Man With a Plan to Rid Oceans of Plastic? His Massive Project to Launch This Summer

trillion trees alive in the world today – so planting a trillion more would be an incredible increase. That’s roughly 150 trees for every person on Earth, according to National Geographic.

“Children could plant 1 million trees in every country on earth and offset CO2 emissions all on their own, while adults are still talking about doing it,” said Finkbeiner. His motto, “Stop talking, start planting,” suggests the same sentiment.

The campaign is working in collaboration with organizations such as the World Wildlife Fund and the Wildlife Conservation Society to meet the ambitious goal. The Campeche province of Mexico is already a staging ground for Finkbeiner’s no-nonsense motto. Plant for the Planet recently bought 33,300 acres (13,500 hectares) in the area and they plan to plant 10 million trees by 2020.

RELATED: Why We Should Practice Forest Bathing and How to Get the Benefits of ‘Forest Medicine’

Other countries’ have their own plans for reforestation too. One province in Pakistan has planted 1 billion trees; China is creating forests as big as Ireland; a group of African countries (Ethiopia, Niger, Mali, etc.) are reforesting degraded land; India recently smashed the world record for planting the most amount of trees in a day; and Latin American nations are signing on to reforestation efforts in the Amazon, as well.

All of these combined initiatives offer great hope for the planet, but organizations aside, Finkbeiner is a textbook example of what we can all do on an individual level to save the planet if we just stop talking and start planting.

DATA MASTER: Breanna McDowell



Truck, Tractor & Auto
Fast Efficient Service

Sam's Tire Shop

Mon-Fri 8 to 5
Sat 8-12
(918) 256-7591
436 S. Wilson
Vinita, OK. 74301-4246

Heroic 20-Year-Old Rushed Back Into Fire To Save Niece

A 20-year-old man in Aberdeen, Washington, is being hailed a hero for rushing into a burning home to rescue his niece and two nephews.

Derrick Byrd is suffering from 2nd and 3rd degree burns on his face, back and arms but he says he "would do it again."

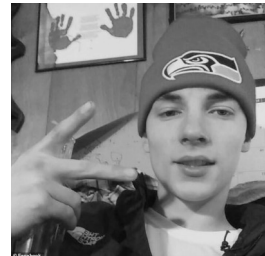

"I'd rather get burnt than her. She's young. She's still got a lot of stuff going for her. She's a good kid," Byrd said about his niece.

When the fire broke, Byrd jumped into action helping the children's mother, Kayla, his sister, get the kids out of the second-floor window.

"I ran downstairs even though I got burnt," he told KO-MO News. "Started catching the kids. I caught Junior and I caught Baby Rory out of Kayla's window."

But 8-year-old Mercedes was afraid to jump and when her mom fell off the roof, Mercedes fell back into the burning room.

"She was screaming my name," said Byrd. "So I wasn't just going to let her sit there. I wasn't going to let my niece die."

"And I just ran up the stairs and pushed through the fire," he said. "I could feel it burning me. I got her and took my shirt off and put it around her face so she wouldn't breath in any smoke and I just carried her out as fast as I could."

Byrd and all three children are being treated at the hospital for burns.

"I would do it again," Byrd said from his hospital bed. "I really would. I don't care. I really would. I'd run back in there and do it again even if I got burnt worse or died."



The family's home appears to be a complete loss, with firefighters and police officers expressing their relief at the fact nobody was killed -- thanks to Byrd's heroic actions.

South Carolina Deputy Saves Baby's Life During Traffic Stop

A South Carolina deputy pulled over a car for speeding.

That traffic stop saved a 12-day-old baby's life.

Deputy W. Kimbro with the Berkeley County Sheriff's Office was conducting routine patrol in the Summerville area of Berkeley County when he stopped a vehicle for speeding.



Upon stopping the vehicle, the driver immediately exited the car and exclaimed that the baby in her vehicle had stopped breathing.

Kimbro knew he needed to act fast to save the baby's life.

In the body cam footage released Thursday, the deputy can be seen feeling for a pulse before beginning to massage little Riley's chest.

"Come on baby, cry for me, cry for me," Kimbro can be heard saying.

Moments later, the baby starts crying.

"As long as she's crying like that she's breathing," he said in the video.

Kimbro was able to get the baby to breathe again until EMS could arrive and take over.

The child was taken to a local hospital for observation and released.

"Because of Deputy Kimbro's steadfast, professional and heroic response, the 12-day old baby was able to live," the sheriff's office wrote on Facebook. "Please join us in congratulating Deputy Kimbro for his gallant actions that prolonged human life. He was awarded the "Life-Saving Medal" from Sheriff Lewis for his heroic actions that day. Well done!"

DATA MASTER: Eric Peachey

John's Body Shop

Collision Repair Professionals
Excellent Color Matching
Unibody And Frame Repair
Glass Replacement
Insurance Claims Welcome
johnsbodyshop85@att.net

918 789-3184

We Repair It Right The First Time



Chelsea

Johnny Parks



Amish Cheese House

BULK FOODS

CHEESES

MEATS

FULL SERVICE DELI

- Jellies, Candies & Jams
- Sugar Free Products
- Spices & Baking Items
- Cheese & Meat Trays
- Gift Boxes
- Kitchen Accessories

Mon - Fri: 9:30a.m. to 6p.m. / Sat: 9a.m. to 5p.m. / Sun: Closed

Wes & Leah Miller

Highway 69 North 918-476-4811 Chouteau, OK 74337

Sherry's Barber & Style
Sherry Green - Stylist
918-256-6887
105 South Vann Street
Vinita, OK 74301

WE PRIDE OUR BUSINESS
ON SERVICE & HAVING
PARTS FOR ALL MODELS
OF VERMEER BALERS

Deweze

1-888-833-7042

Service is Our

#1 Priority!



EUBANKS JORGENSON

CRAIG EUBANKS
MOBILE: 918-961-8048
443858 E 20 RD.
WELCH, OK 74369

Claremore Nursing Home - Employee of the Month



Bart Sanders, Maintenance Supervisor was voted Employee of the Month by the Resident Council. He has worked for this facility for 7.5 years. He was born in Bartlesville OK on August 23, 1978. His beautiful wife of 14 years is also employed here. They have no children but have raised numerous nieces and nephews.

Bart became a Black Belt in Taekwondo and Jujitsu in his teens. His hobbies are tractoring, fishing and video games. When asked what he loved about our facility he said "That's easy —The Residents."

If you would like to join, "Bart Sanders" as a Certified Nurse Aide, please apply in person. Now taking applications for Certified Nurse Aides both days and nights. Must pass a background check. New pay scale for CNA's.

"They may forget your name, but they will never forget how you made them feel."

Maya Angelou

Claremore Nursing Home
920 E. 16th St.
Claremore, Ok. 74017
918-341-1717

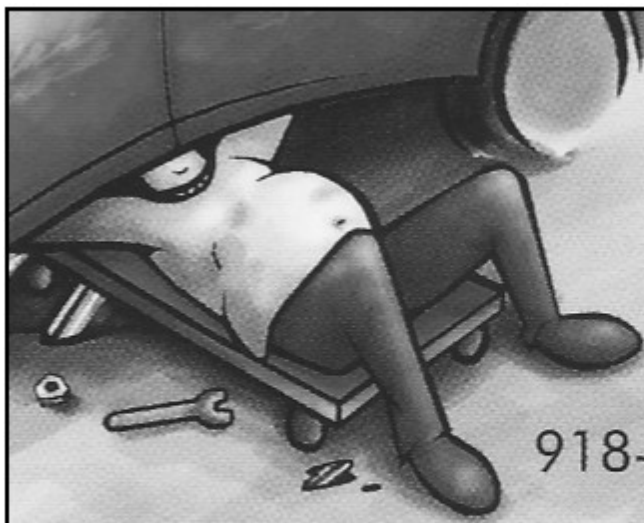

LaCoe And Sons
Automotive

106 S Mayes P.O. 771
Adair, Ok 74330

918-785-4144

If it has wheels, we'll fix it.

Hice LaCoe owner Jeremy LaCoe manager

No One Cheered For This Student As He Received His Diploma - And It Was Beautiful

Jack Higgins approached the stage to receive his high school diploma with his hands over his ears to block what he thought would be applause and cheers.

Instead, he was met by silence.



Jack, 21, has severe autism, and his family worried that he'd struggle at a loud, crowded event. But, the Higgins dreamed of seeing their son walk across the stage and receive his high school diploma.

"He has a lot of sensory issues, noise being one of them," Barbara Higgins said.

Prior to the ceremony, Barbara met with Carmel High School principal, Lou Riolo, and shared her concerns.

Riolo had an idea: have everyone sit in silence as Higgins walked across the stage.

Students can often be unpredictable, so getting everyone to agree to this would not be an easy task.

Before calling Jack to the stage, Riolo asked everyone in attendance to remain silent and offer only a soft golf clap.

Jack walked across the stage to a silent standing ovation.

"The students were amazing. They are a class act and superseded expectations," Riolo told CNN.

"I truly believe people have a kind, compassionate soul and they want to help and this was one of those occasions."

DATA MASTER: Karen Deffenbaugh

Environmentalists Have Removed 40 Tons Of Trash From The Great Pacific Garbage Patch

The nonprofit organization Ocean Voyages Institute has successfully removed more than 40 tons of fishing nets and plastics from the area known as the North Pacific Subtropical Convergence Zone, or more commonly known as the Great Pacific Garbage Patch.



The latest annual clean-up voyage by the sailing cargo ship, S/V KWAH, completed a 25-day clean up mission in the Pacific, between California and Hawaii. In this region, four ocean currents converge to create a vortex that collects huge amounts of plastics.

The ship returned to Honolulu filled with detergent bottles, beer and soft drink crates, bleach and cleaning bottles, plastic furniture, packaging straps, buckets, children's toys, and myriad types of plastic floating mid-ocean.

"Satellite technology played a key role in our recovery effort, offering an innovative solution to finding areas of dense plastic pollution," said Mary Crowley, Founder and Executive Director of OV Institute. "The nets and other debris are signs of the proliferating plastic pollution that poses threats to marine life, coastal environments, shipping, fisheries, wildlife and our health."

OVI has mounted nine previous clean-up voyages to the area but says its latest haul was the largest and most successful to date.

"It is very disturbing to be sailing through what was only decades ago a pristine ocean wilderness and find it filled with our all-too-familiar garbage," says Crowley.

"Urgent action is needed at all levels: curtailing the manufacture of throwaway plastics, preventing plastic trash from entering the oceans, and enlisting the public, corporations, and the maritime industry in education, prevention, innovation and massive cleanup efforts. The question is, are we ready to make it a priority to protect 72 percent of the planet?"

DATA MASTER: Karen Deffenbaugh

Telebank: (918) 476-BANK	BIG Commitment	Time & Temp: (918) 478-4666 (918) 476-8317
P.O. Box 849 215 West Main Street Chouteau, OK 74337	BANK OF AMERICA	Fax: (918) 476-8300 www.chouteauboc.com
LOBBY HOURS	DRIVE-IN HOURS	
Mon-Fri.....9:00-2:30	Mon-Fri.8:30-6:00	
Fri. Evening.....4:00-6:00	Saturday.....8:30-12:00	
Saturday.....9:00-12:00		

Cherry's
Chouteau Mall
Antiques, Collectibles, & Primitives



704 S. Chouteau Ave.,
(Hwy 69 - 1 Mile North of Hwy 412)
Chouteau, OK 74337-2815

918-476-8858
email: cherrysmall@fairpoint.net

Open Daily 10-6

***** We buy one piece or entire Estates *****

DUTCH PANTRY
BUFFET & BAKE SHOP



Craft Items Available

HOURS: Thurs. - Sat. - 8:00am - 9:00pm
Mon., Tues. & Wed. - Until 8:00pm

918-476-6441

VERNON DETWEILER
Main & Railroad
Chouteau, Ok 74337

Husband Plants A Beautiful Garden Of Scented Flowers To Make His Blind Wife Smile Again

In Shintomi Town in Miyazaki Prefecture, there's a beautiful tourist spot that blooms every spring with a carpet of shibazakura flowers. What makes the site truly special is the fact that it's a private residence, and the reason that up to 7,000 people visit on any given day from late March to April is not entirely because of the gorgeous flowers -- it's because of the touching love story that brought the garden into existence.



The land was once a dairy farm, home to a young couple, Mr. and Mrs. Kuroki, after they married in 1956. Rising early every morning, the two tended to a herd of 60 cows while raising two children in the process. It was a tough yet rewarding life on the farm, with the hope that one day, upon retirement, they would be able to take a well-earned trip around Japan.



After 30 years of marriage, Mrs. Kuroki suddenly encountered a problem with her eyes, which turned out to be a complication from diabetes causing her sight to fail just one week later.

Feeling her life was over, Mrs. Kuroki was devastated at the prospect of not being able to go on the trip she and her husband had always dreamed about and didn't want to face a life of immobility.

10 As a result, she shut herself away from the world and

began living a life of seclusion in her home. It pained her husband to see her normally cheerful expression become one of sadness, and he thought that if they could at least have a visitor or two each day, it would encourage his wife to come out of her shell.



One day, Mr Kuroki glanced upon a pink shibazakura flower in the garden and it occurred to him that the beauty of flowers can be experienced not only through sight, but through the sense of smell as well. If he were to create a garden filled with flowers, he thought, his wife could still enjoy their beauty, and people might also come to visit, which would bring a smile to her face again.



Mr. Kuroki spent two years planting the sea of bright pink flowers that would eventually surround their home.



Now, more than a decade after the first seeds were planted, the garden draws visitors from surrounding towns and prefectures, with people hoping for a chance encounter with Mr. and Mrs. Kuroki, who can often be seen walking around the property.



And if you meet Mrs. Kuroki today, you'll see that her husband has brought a huge smile back to her face, all with the help of visitors and flowers.



DATA MASTER: Steven Burdick

WINCHESTER ADVISORY CENTER
FULL LINE BROWNING DEALER

BILL'S SPORTING GOODS
Archery • Black Powder • Ammo
Guns • Reloading

1016 S. LYNN RIGGS
 CLAREMORE, OK 74017

MON - SAT 9-6
 918-341-5388
 FAX 918-341-8449

www.billssportinggoodsok.com

Froman
OIL & PROPANE CO.

"Rogers County's oldest name in propane"

CARY FROMAN
Vice-President

341-4434
 Box 1166
 Claremore, OK 74018

Kindness Observed



I spotted a small child, maybe 6, who noticed another child, who looked maybe 3, on the playground when that little fellow dropped his cupcake.

The older one I spotted walked across the entire playground and tried to help the little guy pick up the cupcake. The cutest and kindest thing was he finally offered the sad little guy his own sleeve to wipe his tears.

A mom, I'm thinking, came over pretty quickly and thanked the older boy, and together they cleaned up the dropped cupcake. When the mom and little one walked away hand in hand, the little boy turned around and waved to the older child, who waved back.

The spontaneous act of kindness on that older child's part, and the simple gratitude showed by the little one was pure and beautiful. It was a gift to me to have caught the moment. I'm grateful for seeing it.

Children can teach us so much about appreciation and kindness, because they have not been marred by the world or people yet. A truly touching story.

DATA MASTER: Breanna McDowell

Light At The End Of Dark Tunnel



I happened to face loneliness and difficulties which made me dull for a while. During, this time, when anyone approached me, respected me or supported me in smallest way, I noticed it and felt grateful.

I had taken small gestures like being welcomed, thought-of or included for granted. However, during this emotional phase, I noticed each of these and was humble, simple and thankful to others.

I had built walls around myself and was keeping my distance (having dutiful relations, not friendly connections) with a few people (this even included family members) because of holding small grudges against them. During, this trying phase, when they were kind in little ways, i noticed it and was able to acknowledge and accept it.

I realize some of these walls were either shaken or partly broken. Now, if these same people are able to interact with me, invite me or call me; freely, as a friendly connection ; I notice the difference in quality and feel happy about it.

Sometimes, it takes adversaries to create holes in walls, through which light can enter. The universe is so generously giving , that every dark cloud has at-least one silver lining. My faith is restored: There is always light at the end of the tunnel! Every action matters tremendously.

DATA MASTER: Breanna McDowell

Proudly Accepting: **SOONERCARE & MEDICAID**



HAPPY TOOTH
Jonah R.B. Vandiver, DDS & Associates

TOOTH-COLOR FILLINGS
RELAXING GAS • CLEANINGS
EXTRACTIONS • SEALANTS
X-RAY/EXAMS • EMERGENCIES
NEW Patients Welcome!
We love working with both children & adults.



HappyToothOK.com

900 E. Will Rogers Blvd, Suite A • CLAREMORE **341.6900** 7104 S. Sheridan Suite B • TULSA **492.8793**

'I'm the Father I Wish I Had Growing Up': Man Who Grew Up In Foster Care Adopts 3 Boys



Barry Farmer is now a father to three boys, due largely to his own experience growing up in foster care, which steered him towards adoption.

Farmer grew up in Kinship Care, a form of foster care in which a relative steps in to care for a child if their parents aren't able to.

While living with his grandmother as his legal guardian, Farmer says he learned how to be responsible for himself, and as she got older, he learned how to care for her when she needed help.

But when he turned 21, he had an idea: he applied for a foster license to take children in, too.

"Becoming a foster parent was like a tribute to my grandmother because I could never pay her back, but I was definitely able to pay it forward," Farmer, 30, of Richmond, Virginia, told People.

After he got his foster license, he was placed with then-eight-year-old Jaxon, with the plan originally being for him to reunite with his biological family.

But after a year, Jaxon wanted to stay with Farmer.

"It was touching that this child of a different race felt comfortable enough to call me Dad; he was a child searching for belonging in a not so typical situation," Farmer said.

Two years later, in 2013, Farmer adopted Xavier, giving Jaxon a little brother. Then, in 2014, he adopted Jeremiah, who was four at the time and in the foster care system.

"Fatherhood has been everything I imagine it to be because I'm the father I wish I had growing up. I'm involved, I'm there when my boys go to sleep and when they wake up," Farmer said. "I'm their biggest cheer-

leader when helping them achieve their goals. I try not to miss a beat in their lives. I take the responsibility of being their father very seriously and never for granted."

Since adopting them, the three boys are growing out their hair along with Farmer. They plan to donate their hair to cancer organizations when it's long enough.

A Message from Barry Farmer



Please know, children in Kinship Care could possibly carry the same feelings of loss as an adoptee. This my first Christmas living with my Grandmother. I was still getting to know her since we didn't have a relationship prior to me moving in. Check out the MC Hammer doll lol. This was my new normal, my new beginning, stability. My Grandmother didn't have a lot to give me but it was more than what I ever had up until that point. I was fed, well groomed, my own room and loved. I may not have had what other children around me had growing up, but I did have a CHANCE. Because I realize not everyone gets a CHANCE. Anyone that tries to tell you that you don't need to be grateful for a CHANCE to heal, only want you to suffer in their misery. I refuse to do that. I choose to react to my present so that my future can be peaceful. THIS PICTURE BRINGS ME PEACE. To my fellow KinshipCare/FosterCare/Adoptees, I hope you find your peace. Foster Parents and Adoptive Parents I hope the children in your care find their peace.

DATA MASTER: Breanna McDowell



INNOVATIONS IN HAIR
COMPLETE HAIR CARE
MANICURES & PEDICURES
918-825-2570
459 S. Wood
PRYOR, OK 74361

Businessman Is Donating 10,000 Bikes To Kids Who Walk Miles To School

A businessman in Myanmar has bought 10,000 bikes from bike-sharing companies and is donating them to underprivileged children across the country who walk miles to school.



Entrepreneur Mike Than Tun Win, founder of Flymya.com and chief executive of BOD Tech Co, created a non-profit organization called LessWalk which is buying up the bikes and making them suitable for students.

"It's a common sight to see lines and lines of students walking long distances from home to school in rural villages," Than told Tech Crunch. "Some students can walk up to one hour from home to school and the families can hardly afford a simple form of transport like bicycle or motorcycle... a school bus is almost unheard of to the students in rural villages."

Than was able to purchase the bikes at \$40 per bike, costing a total of \$400,000. Half of the money for the project has been funded through donations to LessWalk. Than himself provided the rest.

"Suddenly, there was an opportunity to buy [these bikes] at fraction of price. The benefit it can develop is well beyond that cost," he said.

In a country with more than nine million students, Than plans to work with government organizations to identify potential beneficiaries. The primary focus is students aged 13-16 who walk over a mile to school each day.

"I'm only halfway through the journey. The remaining 50 percent is making sure we have an impact," Than said.

DATA MASTER: Steven Burdick

Man Drives 1,200 Miles To Rescue Family Stranded In Australian Outback

A good Samaritan embarked on a 1,200 mile roundtrip to rescue a family whose car had broken down in the middle of Northern Territory, Australia.



Daryn Melrose, his wife and two daughters were driving from Gippsland to compete in the national minnow sailing championships when their car broke down in Tennant Creek.

The family was stranded on the side of the road along with their trailer containing two small boats.

Rodney Sims, who lives about 600 miles from where the family had broken down, was on his day off and scrolling through Facebook when he saw a post by ABC Darwin about the stranded family.

"About 30 years ago, strangely enough, I was in a similar situation with a broken-down car and someone helped me out ... this was my time to give back," Sims told ABC News.



Sims left his home late Friday night, met up with the family in Tennant Creek, and had them in Darwin on Saturday in time for the race.

"He drove all the way down to us, hooked up the trailer, and drove us all the way back to Darwin," Melrose said.

"My daughters and I could not be more grateful for his efforts. They got here on time and are hoping for podium finishes after their competitions.

Territory folk are incredibly special."

While the family arrived in time for the competition, their car was left behind.

"Hopefully the car will arrive in Darwin some time today and get taken to a mechanic," Melrose said. "It was more important to get the girls and the boats up here in time for their race. The car will have to wait."

DATA MASTER: Doug WM Stone

Grandma Missing 5 Days Is Found Alive After Grandson Decides To Search One Last Time

A grandmother who had been missing for five days was found alive in the woods behind her apartment complex in Charlotte, NC.



Sandra Adams, 69, was reported missing after family members went to check on her at her apartment Friday morning.

They said Adams was last seen Wednesday and was known to walk around her complex but always returned home.

After days of searching, Adams' grandson, Nate Cassel, and his friend, Shawn Willis, decided to search one last time.

"He wanted to go look in the woods. I woke up this morning with the same idea: Let's go search the woods in the neighborhood," Willis told WSOC.

On Monday morning, Cassel and three of his friends fought their way through the heat and heavy brush along the small creek behind Adam's place.

They searched for about a quarter mile until they found her near the park, lying face down in the creekbed.

For a few heartbreaking moments, Cassel thought he had lost her and called the police.

"We got a call about finding a possible deceased person in the creekbed," said CMPD Officer Brian Nicholson.

When Nicholson got to the park, he said Willis showed him where they found the body, but then something remarkable happened.

As we were coming toward her, she raised her arm up," Nicholson said.

Everyone was in shock.

"It's a blessing. It's a blessing, a big blessing, a miracle," Cassel said.

Police told WSOC that Adams gathered enough strength to tell them she fell while going on a walk.

DATA MASTER: Doug WM Stone

"I am glad a friend told me about..."

**GRAND
PROSTHETICS**
& Orthotics

Lightweight
ARTIFICIAL LIMBS & BRACES

FREE CONSULTATIONS

(918) 786 4626 www.GrandPro.com
5 East 14th St Grove Ok 74344

Up-coming Events

TOPS #570 We meet 9am to 11am Monday morning at Mt. Olive Lutheran Church in Miami 2337 N. Main St. "Taking off pounds sensibly!"

TOPS #567 meet every Thursday at 10am 433 N Mississippi in Nowata.

TOPS #506 in Miami Heavenly Winds Worship Center meet every 6pm Monday evening. For more info call Susan Walls at 918-540-0570

Every 4th Saturday of the month Veteran's Support Group: Veterans for Veterans. Have you served in the military? Are you struggling with readjustment? Anxious about the future? Struggling to connect with friends and family? Struggling with school? WE CAN HELP! Free veterans support group at 10am every 4th Saturday of the month. The Landing 502 West Corner Fairland, Ok. For more information call Larry Boyd (918) 541-7592 or Cindy (918) 676-3228.

Food Truck Wednesdays —Every Wednesday, grab some tasty eats and gather on the grounds of Guthrie Green. During Food Truck Wednesdays, lunchtime transforms into a community-wide affair, with roaming food trucks posting up at this Tulsa park. While you dine on delicious food, be sure to enjoy the live music and fresh air. Guthrie Green 111 E Brady St Tulsa, OK 74103 Phone: 918-574-2421

Chelsea Dance and Jam Session—Every Friday Night 6:00 pm—9:00 pm—Bring a dish for potluck at 6:30 pm. Musicians are welcome. Civic Center 618 Pine street Chelsea, OK 74016

Big Cabin Senior Exercise Program—Fitness program for seniors held at the Big Cabin Baptist Church gym three times a week, Monday, Wednesday and Friday, from 10 to 11 a.m.

American Legion Post 178 in Grove, OK – Bingo every Saturday evening at 6pm. Family atmosphere. Contact Lee Cathy for any questions at: 901-487-9060

Aug 08, 2019 - Aug 10, 2019 Pawnee Bill Memorial Rodeo - The Pawnee Bill Memorial Rodeo is IPRA sanctioned with seven standard events including bare-back bronc riding, bull riding, saddle bronc riding, calf roping, steer wrestling, cowgirl barrel racing and team roping. Come for a weekend of family entertainment and exciting rodeo action with performances held nightly. Crowd favorites at this annual event include a wild horse race, wild cow milking, wild sheep riding and bull poker. A rodeo queen will be crowned and dances will be held each night after the main event.

SUDOKU PUZZLES

Fill in the grid with digits in such a manner that every row, every column and every 3X3 box accommodates the digits 1-9, without repeating any.

7		4			1	6		
3		1	2			5		
				5	6			7
		3	1					8
		2				4		
1					8	3		
5			4	3				
		6			2	7		1
		8	6			9		4

Hardship level: Moderate

	9	2			1			
	4		7				2	
5	1							
1		6		2			4	5
2			3	6	7			8
9	8			1		7		2
							8	9
	3				2		7	
			4			6	5	

DATA MASTER: Nikki Hamilton
Solutions are printed in page 36

Lakeside Arena Pawnee, OK 74058 Phone: 405-880-7218, 918-762-2108

Aug 09, 2019 - Aug 11, 2019 Green Country Roots Festival - Celebrate the arts during the Green Country Roots Festival in Tahlequah. This family-friendly festival brings together an amazing array of regional bands, artisans, comedians, dancers, poets and filmmakers to spotlight the area's distinct artistic voice. Live performances occur Friday and Saturday, then stay for Sunday's Native American Pow Wow. Presented by the CBIHP Foundation and held at Norris Park in downtown Tahlequah, this festival also features a great variety of art, food and drink vendors. 400 N Muskogee Ave Tahlequah, OK 74464 Phone: 918-822-0167

Aug 09, 2019 Crayons Improv Comedy Show - Get ready to laugh at this family-friendly, improvised comedy show. Crayons Improv uses audience suggestions, participation and drawings to create unique and hilarious scenes in a G-rated show that is suitable for the whole family. Get to know Crayons' whacky and memorable characters as the troupe performs their own brand of short-form comedy, featuring old-time favorite improv games along with brand new ones. Come to the Heritage United Methodist Church in Broken Arrow and see a fun, light-hearted comedy troupe that has been tickling funny bones across the country since 2007. Heritage United Methodist Church 5300 E Kenosha St Broken Arrow, OK 74014 Phone: 918-557-5616

Aug 09, 2019 - Aug 10, 2019 Okmulgee Invitational Rodeo & Festival Okmulgee's Invitational Rodeo is the nation's oldest African-American rodeo, one of the state's longest running rodeos and one of the largest African-American sporting events in the nation. Entertaining audiences since 1956, the Okmulgee Invitational Rodeo also features a festival and parade Saturday afternoon. Several vendors set up to serve the crowd refreshments, and there will also be arts and craft booths for a perfect souvenir of this historic rodeo. Creek Nation Omniplex Arena Okmulgee, OK 74447 Phone: 918-758-7044

Aug 09, 2019 - Aug 11, 2019 Powwow of Champions - The ORU Mabee Center in Tulsa will come alive in a colorful expression of dance, drum music and song as members of tribal nations from around the country gather to honor, strengthen and share traditions with each other and the general public at this year's Powwow of Champions. Over 300 dancers, dressed in full Native American regalia, will participate throughout the weekend in ceremonies and dances, including awe-inspiring grand entries, intertribal dances and dance competitions. Tulsa Mabee Center 7777 S Lewis Ave Tulsa, OK 74171 Phone: 918-378-4494

Aug 09, 2019 to Aug 18 National Snaffle Bit Association World Show - The National Snaffle Bit Association brings together horses and riders from all over the country for its annual World Show at Tulsa Expo Square. This competition of pleasure horse events includes horsemanship, equitation over fences, western pleasure, hunter under saddle, hunter hack and more. Riders and horses from all different classes compete at this nearly week-long event. The NSBA will offer all-breed classes and pay out in excess of \$500,000 in cash and prizes. A trade show comprised of commercial exhibitors and pleasure horse professionals will be available to assist spectators during the week. Tulsa Expo Square 4145 E 21st St Tulsa, OK 74114 Phone: 847-623-6722 Fax: 847-625-7435

Aug 10, 2019 - Sep 21, 2019 Cherokee Homecoming Art Show - Visit the Cherokee Heritage Center in Tahlequah for the Cherokee Homecoming Art Show. View authentic Cherokee artwork by artists from all across the nation. Open to citizens of the Cherokee Nation, United Keetoowah Band of Cherokees and Eastern Band of the Cherokees, this show will display many examples of traditional and contemporary art. The judged artwork categories in the past have included pottery, basketry and painting. The Cherokee Homecoming Art Show is a great venue for Cherokee artists to present their artwork to the public. Cherokee Heritage Center 21192 S Keeler Dr Tahlequah, OK 74465 Phone: 918-456-6007 Toll Free: 888-999-6007 Fax: 918-456-6165

Aug 10, 2019 Second Saturday Architecture Tour Take a fun and educational walking tour through downtown Tulsa the second Saturday of each month with the Tulsa Foundation for Architecture. The Second Saturday Architecture Tour is a one-and-a-half hour walking tour that gives an insightful look into the exciting architecture that abounds in downtown Tulsa. Hit the highlights of Tulsa's prestigious architectural collection and learn something new about the buildings around you. 115 W 5th St Tulsa, OK 74103 Phone: 918-583-5550

Do You have an event that you would like to share ?
Community Links of Chelsea
1100 Walnut/PO Box 85
Chelsea, OK. 74016
Ph: 918-789-2862
Fax: 918-789-5296

DATA MASTERS: Steven Burdick and
Eric Peachey

Quotes From Thinkers Around The World

“Do not give them a candle to light the way, teach them how to make fire instead. That is the meaning of enlightenment.”

Kamand Kojouri

“Why do you feel so powerless? Go spend an hour with ants. Each of those black specks you see is a life. One whole life that you can save, take, or affect in some way. You have the power to make so many lives better. It is within you. Don't lose sight of that.”

Kamand Kojouri

Goals and objectives are based on theories and foundations.

Abdolkarim Soroush

It is impossible to advance new theories... when you are under the influence of a particular view, or under the pressure of a particular dogma.

Abdolkarim Soroush

We coin concepts and we use them to analyse and explain nature and society. But we seem to forget, midway, that these concepts are our own constructs and start equating them with reality.

Abdolkarim Soroush

Good, better, best. Never let it rest. 'Til your good is better and your better is best.

St. Jerome

It does not matter how slowly you go as long as you do not stop.

Confucius

Beginning today, treat everyone you meet as if they were going to be dead by midnight. Extend to them all the care, kindness and understanding you can muster, and do it with no thought of any reward. Your life will never be the same again.

Og Mandino

The best and most beautiful things in the world cannot be seen or even touched—they must be touched—they must be felt with the heart.

Helen Keller

My mission in life is not merely to survive, but to thrive; and to do so with some passion, some compassion, some humor, and some style.

Maya Angelou

When a deep injury is done us, we never recover until we forgive.

Alan Paton

Sorrow is better than fear. Fear is a journey, a terrible journey. But, sorrow is at least an arriving.

Alan Paton

But there is only one thing that has power completely, and this is love. Because when a man loves, he seeks no power, and therefore he has power.

Alan Paton

Pain and suffering, they are a secret. Kindness and love, they are a secret. But I have learned that kindness and love can pay for pain and suffering.

Alan Paton

The Judge does not make the law. It is people that make the law. Therefore if a law is unjust, and if the Judge judges according to the law, that is justice, even if it is not just.

Alan Paton

The people of this world are like the three butterflies in front of a candle's flame.

The first one went closer and said:
I know about love.

The second one touched the flame
lightly with his wings and said:
I know how love's fire can burn.

The third one threw himself into the heart of the flame and was consumed. He alone knows what true love is.

Farid al-Din Attar

If you will but aspire
You will attain to all that you desire.
Before an atom of such need the Sun
Seems dim and mirky by comparison.
It is life's strength, the wings by which we fly
Beyond the further reaches of the sky.

Farid al-Din Attar, The Conference of the Birds

How strange it was that man could neither brook
The presence nor the absence of his look!
Farid al-Din Attar, The Conference of the Birds

Had I known how listening is superior to speaking, I
would not have wasted my life preaching.

Farid al-Din Attar, The Conference of the Birds

His part is mercy, ours is endless praise.

Farid al-Din Attar, The Conference of the Birds



Getting to know the

Ordinary People

A sad pattern appears in Scripture in the Book of Judges. The people forsook the Lord and followed other gods. They were attacked and conquered by their enemies. Then they cried out to the Lord and He raised up judges. Despite their disobedience, God showed His mercy to the people and saved them from their oppressors. It's interesting that most of the judges were ordinary people whom God called and sent to lead.

Consider Gideon, Barak, Samson, and Jephthah. Hebrews 11 lists them as heroes of faith. The judges were ordinary people, sinful human beings whom God called. The Bible honors them for their faith, not for their perfection. The measure of their lives – and ours – is not the absence of failure, but the presence of God’s grace in His forgiveness, His gift of faith, and His call to His faithful people.

We are among these ordinary people. Yet, in Christ, God has given us the extraordinary: He has given us His undeserved mercy and boundless grace in Jesus Christ. We don't deserve any of it. Yet God has joined us together with the saints who have gone before us, through faith in Him. We pray our lives reflect the extraordinary mercy He has given us in Jesus. Amen.

<p>Messiah Lutheran Church 460 N. Wilson, Vinita, OK. Sunday School and Bible Class 9:00 a.m. Worship 10:00 a.m. 918-256-3223 Email: messiahvinita@aol.com</p>	<p>St. Paul Lutheran Church Washington and Pine, Fairland, OK. Sunday School and Bible Class 9:15 a.m. Worship 10:30 a.m. 918-676-3059 Email: stpaulluthch@aol.com</p>
<p>Bethlehem Lutheran Church 6911 West 380 Road, Adair, OK 74330 Worship 9:00 a.m. 918-785-2994 Sunday School and Bible Class 10:15 a.m.</p>	<p>Immanuel Lutheran Church 706 Rockwood Drive, Grove, OK. Worship 9:30 a.m. 918-786-4585 Website: www.lutheransonline.com/lo/Groveok</p>
<p>Mt. Olive Lutheran Church 2337 North Main, Miami, OK 74354 Worship 2:00 p.m. (918) 542-4681 Sunday School and Bible Class 3:00 p.m. Email: mtolive@cablone.net</p>	<p>Redeemer Lutheran Church 220 N. Seminole, Claremore, OK. Sunday School and Bible Class 9:00 a.m. Worship 10:30 a.m. 918-341-1429 Email: rluther@sbcglobal.net – Website www.rlccok.org</p>
<p><i>Guests are always welcome.</i> <i>See you Sunday at worship.</i></p>	<p>St. John Lutheran Church 607 SE 9th Street, Pryor, OK. Sunday School and Bible Class 9:15 a.m. Worship 10:30 a.m. 918-825-1926 Email: stjohncpyor@sbcglobal.net - Website: www: stjohncpyor.org</p>



Can you find following hidden objects in the picture printed on the next page?

Tube of toothpaste, question mark, book, crown, pennant, scissors, ring, house, golf club, spoon, butterfly, vacuum cleaner, rabbit, baseball cap, artist's brush, dolphin, pie, worm, baseball bat, and megaphone.

Prehistoric Pals
By Michael Palan



Crossword Puzzle

Crossword #48R69VCU



Down

1. Golden State wine region
2. Eight, in Essen
3. Miracle Whip alternative
4. Risky
5. No. Cal. paper since 1865 (abbr.)
6. Former Nixon chief of staff
7. Hymn word
8. Big cheese
9. Adobe software
10. John ____
11. Coastal bird
12. Finish up
13. Web feed standard
18. Lapel label
22. Cousins
24. Riffraff
26. What suspicious ones smell?
27. Secret message
28. Cardiology concern
29. Promulgate
30. Vocalists' limits
31. Chinese ideal
32. "Knock ____!" (exasperated parent's cry)
33. Round up
34. Stocking stuffer
38. River of Xanadu
40. Cat of the zodiac
41. "I ____ sorry!"
44. Buckeyes
46. In armed conflict
49. Flightless bird
50. San Fran gridders
51. Gets a glimpse of
55. Brother of Seth
56. This, to Tomás
58. "There wasn't ____ eye in the house"
59. Steering strap
60. Juan's 3
61. Actress Arthur
62. Danube city
63. 66, for one
64. Calendar doz.
66. Nautical swerve

Across

1. Killer whale film
5. ____ tzu (dog breed)
9. "Doe, ____": song lyric
14. Open up ____ of worms
15. Vegas card game
16. Preserves, as beef
17. Doctor
19. Rives
20. "As loathsome as ____": Shakespeare
21. Lizard that chirps
23. Bragg and Dix (abbr.)
25. Small patio grill
30. Stick-in-the-muds
33. Fit ____ fiddle
35. Neighbor of Belize, briefly
36. Spanish snacks
37. Supernatural power
39. Green stuff
42. Via, briefly
43. ____-Saxon
45. Govt. disaster agency
47. French summer
48. "Oh! Susanna" songwriter
52. Uncooked fish dish
53. Reactions to pinches, perhaps
54. Pound portion
57. With space between
61. Union of Myanmar, familiarly
65. 1969 biker film
67. Rocker ____ John
68. Hayworth or Gam
69. Pennsylvania city
70. Make ____ of: botch
71. Put one over on
72. Some dict. listngs

Word Search Puzzle

X G I R D L E J I G S A W S
 H G F L I E R U N E S G T B
 M N E A G S N I R U I N E D
 O I R Y U S K U L S E T I R
 W R N L A L T Y T I S R A V
 E E S L U R T G N I Y L F B
 D E I A O S N E O R K E R O
 E V C T U I L O M G O A C A
 A L S R W N T I I O G C E S
 L E W O V O M I T S C L D T
 E U D M R B R A D N I L E F
 R N N S K C U T S N U V S U
 E H O G G I N G H K A A O L
 D I N N E R S E P O L B H W

Bandit
 Boastful
 Brags
 Caulking
 Cedes
 Comet
 Corny
 Dealer
 Dinners
 Endowing
 Fault
 Ferns

Flying
 Girdle
 Goggle
 Haunt
 Hogging
 Hosed
 Jigsaws
 Lenient
 Lopes
 Lunge
 Mortally
 Mowed

Risky
 Rites
 Ruined
 Runes
 Saliva
 Stylus
 Torso
 Trots
 Tuned
 Unmask
 Unstuck
 Until

Varsity
 Veering
 Vision
 Vowel
 Wield
 Worth

CryptoQuote Puzzles

Title: Justify Salary **Quote From:** Drew Carey

A	B	C	D	E	F	G	H	I	J	K	L	M	N	O	P	Q	R	S	T	U	V	W	X	Y	Z
										J									B			E			

T _____ **'** _____ **W** _____ **T** _____
 B Y V F V X H O E P Z M A P H Q L X B M W Z
 _____ **L** _____ **L** _____ **L** _____ **T** _____ **'** _____ **L** _____
 U Z X P J P F Z J V G V J R L B M U J V P F H M
 _____ **T** _____ **L** _____ **W** _____ **T** _____ **T** _____
 H K B O J M G V E M B Y M B

Title: Dumb Blonde **Quote From:** Dolly Parton

A	B	C	D	E	F	G	H	I	J	K	L	M	N	O	P	Q	R	S	T	U	V	W	X	Y	Z
	16		21		7			3		1															

I _____ **'** _____ **F** _____ **F** _____ **D** _____ **D** _____ **B** _____
 3 15 19 10 22 10 7 7 5 19 21 5 21 16 8 6 26 26 22 24 5
D _____ **B** _____ **B** _____ **D** _____ **K** _____ **B** _____
 21 25 15 16 16 26 10 19 21 5 20 10 1 5 17 16 5 18 6 25 17 5
I _____ **K** _____ **I** _____ **'** _____ **D** _____ **B** _____ . . . **D** _____ **I** _____
 3 1 19 10 12 3 15 19 10 22 21 25 15 16 6 19 21 3
 _____ **K** _____ **I** _____ **'** _____ **B** _____ **D** _____
 6 26 17 10 1 19 10 12 22 24 6 22 3 15 19 10 22 16 26 10 19 21 5

Title: Man's Character **Quote From:** Abraham Lincoln

A	B	C	D	E	F	G	H	I	J	K	L	M	N	O	P	Q	R	S	T	U	V	W	X	Y	Z	
											H	Π			⊕											

N _____ **M** _____ **N** _____ **N** _____ **N** _____
 Π T I N A K I A A H T Π O I Π X B I Π Λ I Λ M T N X
 _____ **N** _____
 Ω B K ϑ ζ B Ω Γ K P ζ Δ I Π B B P B T X B
M _____ **N** _____ **M** _____
 I H I Π X O E I N I O B T N E Ω M T E Ω H
P _____
 ⊕ P Δ T N

Building Bridge Puzzle

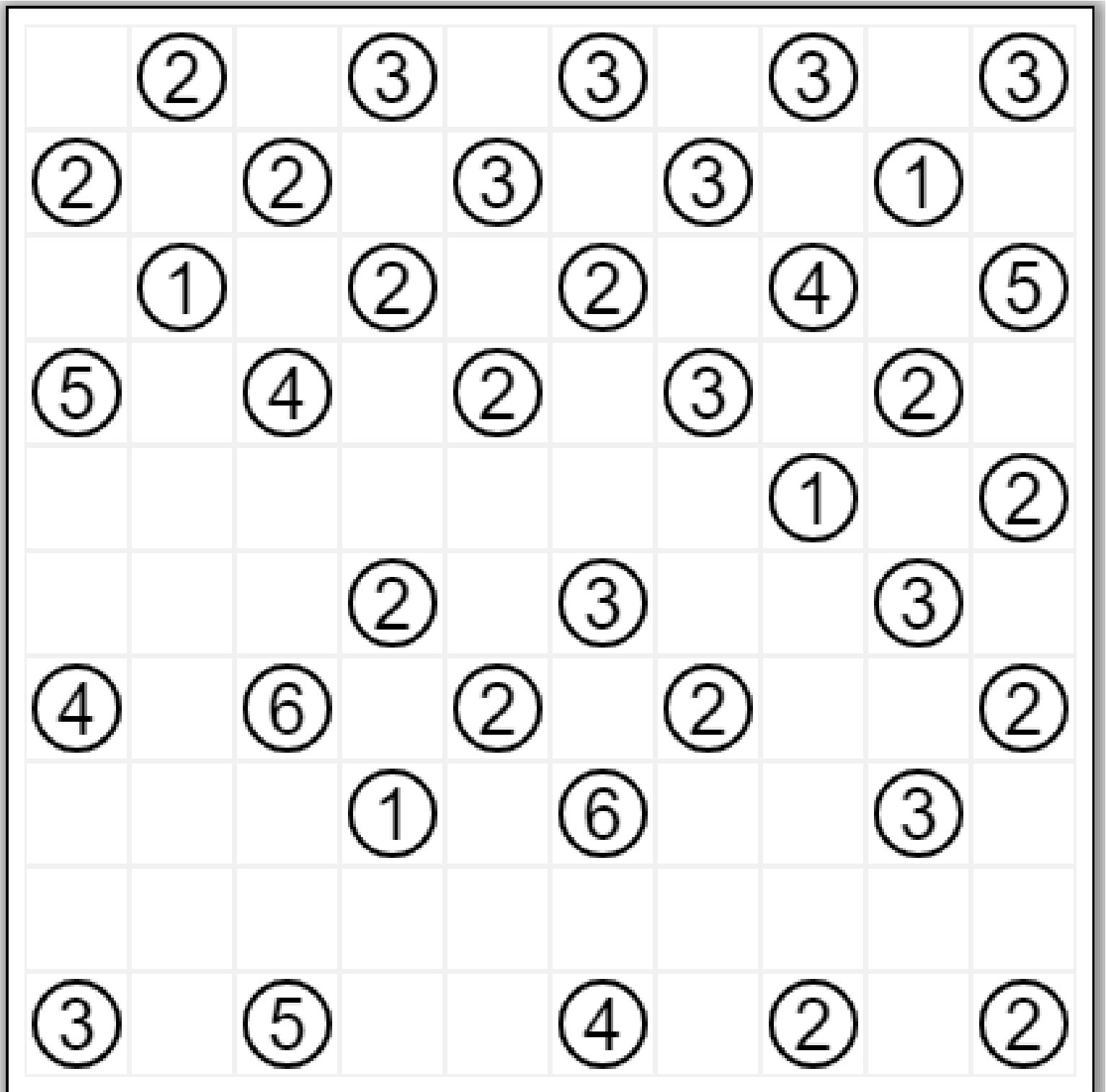

Solution on page 30

Logic Puzzle



	Women					Men					Songs				
	Ana	Melanie	Tamara	Virginia	Yolanda	Adrian	Frank	Jeff	Martin	Ovril	Came Cruda	Elegy in C	Galician Day	Miss Saigon	Warsaw Nights
Points	27.5														
	27.8														
	28.1														
	28.4														
	28.7														

Songs	Ana	Melanie	Tamara	Virginia	Yolanda	Adrian	Frank	Jeff	Martin	Ovril
Came Cruda										
Elegy in C										
Galician Day										
Miss Saigon										
Warsaw Nights										

Logic Puzzles

Presented by Puzzle Baron

Puzzle ID: S131WI

For hints, solutions and more puzzles, go to www.Printable-Puzzles.com!

Points	Women	Men	Songs
27.5			
27.8			
28.1			
28.4			
28.7			

Points	Women	Men	Songs
27.5			
27.8			
28.1			
28.4			
28.7			

- Virginia's pair didn't skate to Galician Day..
- The team that skated to Miss Saigon scored somewhat lower than Adrian's pair..
- Of the team that skated to Warsaw Nights and Ana's pair, one finished with 27.5 points and the other included Adrian..
- Of Ovril's pair and Yolanda's pair, one skated to Elegy in C and the other finished with 28.7 points..
- Virginia's pair was either Frank's pair or Ovril's pair..
- The pair that skated to Warsaw Nights, the pair that scored 28.7 points, Adrian's pair and Frank's pair were all different pairs..
- Of Ana's pair and the team that scored 28.1 points, one included Jeff and the other skated to Carne Cruda..
- Melanie's pair scored somewhat lower than Jeff's pair..

Solution is on page 28

Answers to Riddles

1. Mt. Everest; it just wasn't discovered yet.
2. Fire
3. A shadow
4. Billy lives in the Southern Hemisphere.
5. A palm
6. An alarm clock.
7. Thunderwear.
8. Secret
9. The letter "M"
10. It was a bright, sunny day.
11. The idols from left to right are: God of Diplomacy, God of Falsehood, God of Truth. The God of Truth is not seated on the left because he always speaks the truth whereas the idol on the left replied that the God of Truth is seated at the centre. The God of Truth is also not seated in the centre as he always speaks the truth but the idol at the centre replied that the God of Diplomacy is seated at the centre. Therefore, the God of Truth is seated on the right. As God of Truth is seated on the right, and he always speaks the truth, then the The God of Falsehood is seated at the centre. The God of Diplomacy is seated on the left and he has lied.
12. Television.
13. Turn on the first switch and wait for a while. Turn off the first one and turn on the second. Go into the room. One bulb is shining, the second bulb is hot and the third one nothing.
14. History.
15. Your name.
16. An Echo.
17. Skull.
18. Today

Logic Puzzle Solution

28.7	28.4	28.1	27.8	27.5
Tamara	Ana	Yolanda	Virginia	Melanie
Ovril	Adrian	Jeff	Frank	Martin
Galician Day	Carne Cruda	Elegy in C	Miss Saigon	Warsaw Nights

DATA MASTER: Nikki Hamilton

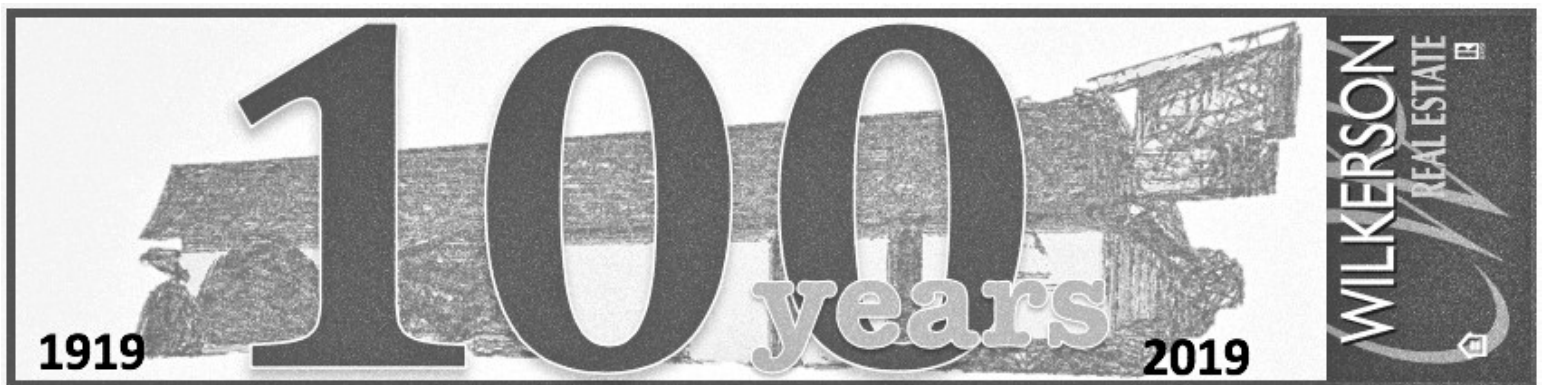



Library News

CATOOSA PUBLIC LIBRARY

105 E. Oak (918) 266-1684

Hours:

Monday thru Thursday: 9am to 7pm
Friday: 9am to 12pm & 1pm to 3pm
Saturday: 10am to 2pm
Closed Sunday

CHELSEA PUBLIC LIBRARY

618 Pine (918) 789-3364

Hours:

Tuesday: 10:00am to 7:00pm
Wednesday, Thursday & Friday: 10:00am to 4:00pm
Saturday: 9:00am to Noon Closed Sunday & Monday

CHOUTEAU PUBLIC LIBRARY

307 W Main Phone: 918-476-4445

Hours:

Mon - Fri - 10AM to 5PM
Closed Saturday & Sunday

DELAWARE COUNTY LIBRARY

429 S. 9th St. Jay, Oklahoma (918) 253-8521

Web: www.eodls.lib.ok.us/jay.html

Hours:

Mon., Wed., & Fri. 9:00am to 6:00pm
Tues. & Thurs 9:00am to 8:00pm
Sat. 9:00am to 1:00pm
Closed Sundays and Holidays

GROVE PUBLIC LIBRARY

1140 NEO Loop (918) 786-2945

Toll free in the 918 area code: 1-888-291-8150

Fax: (918) 786-5233

Hours:

Mon., Wed., & Fri.: 8:30am-5:00pm
Tues. & Thurs.: 8:30am-9:00pm
Sat. 8:00am-12:00pm
Closed Sunday

LANGLEY PUBLIC LIBRARY

325 W Osage Ave. (918) 782-4461

Hours:

Mon.-. 1:00pm to 7:00pm
Tue.-Fri. 9:00am to 12:00pm
And 1:00pm to 5:00pm
Closed Sat. & Sun.

MIAMI PUBLIC LIBRARY

200 N. Main (918) 541-2292

Hours:

Sun. 1:00pm
Mon., Wed., Thurs., 9:00am to 8:00pm
Tues., Fri., Sat., 9:00am to 5:00pm

NOWATA CITY-COUNTY LIBRARY

224 S. Pine (918)273-3363 Fax: (918)273-1818

Hours: Mon-Fri 10^{am}-6^{pm}; Sat 9^{am}-12^{pm}

PRYOR PUBLIC LIBRARY

505 E. Graham, Pryor 918-825-0777

Hours:

Monday & Thursday: 1:00 PM-9:00 PM
Tuesday, Wednesday & Friday:9:00AM-5:00PM

SALINA PUBLIC LIBRARY

420 E. Ferry St. (918) 434-8001

Hours: Tue. 12pm-7pm, Wed. 12pm-5pm,
Thurs. & Fri. 10am-5pm
Closed Saturday, Sunday & Monday

TALALA AREA PUBLIC LIBRARY

106 W Watova St. (918) 275-4540

Hours:

Monday - Friday 2pm to 5pm
Monday and Thursday evening 6pm to 9pm
Saturday 11am to 2pm

VINITA PUBLIC LIBRARY

215 W. Illinois (918) 256-2115

Hours:

Mon., Tues., Wed., & Fri. 11:00am to 6:00pm
Thurs. 11:00am to 7:00pm
Sat. 11:00am to 3:00pm
Closed Sunday

WILL ROGERS LIBRARY

1515 N. Florence, Claremore OK (918) 341-1564

Hours:

Mon & Tues. 9:30am to 8:00pm
Wed. & Thurs. 9:30am to 6:00pm
Fri. & Sat. 9:30am to 5:00pm

Building Bridge Puzzle Solution

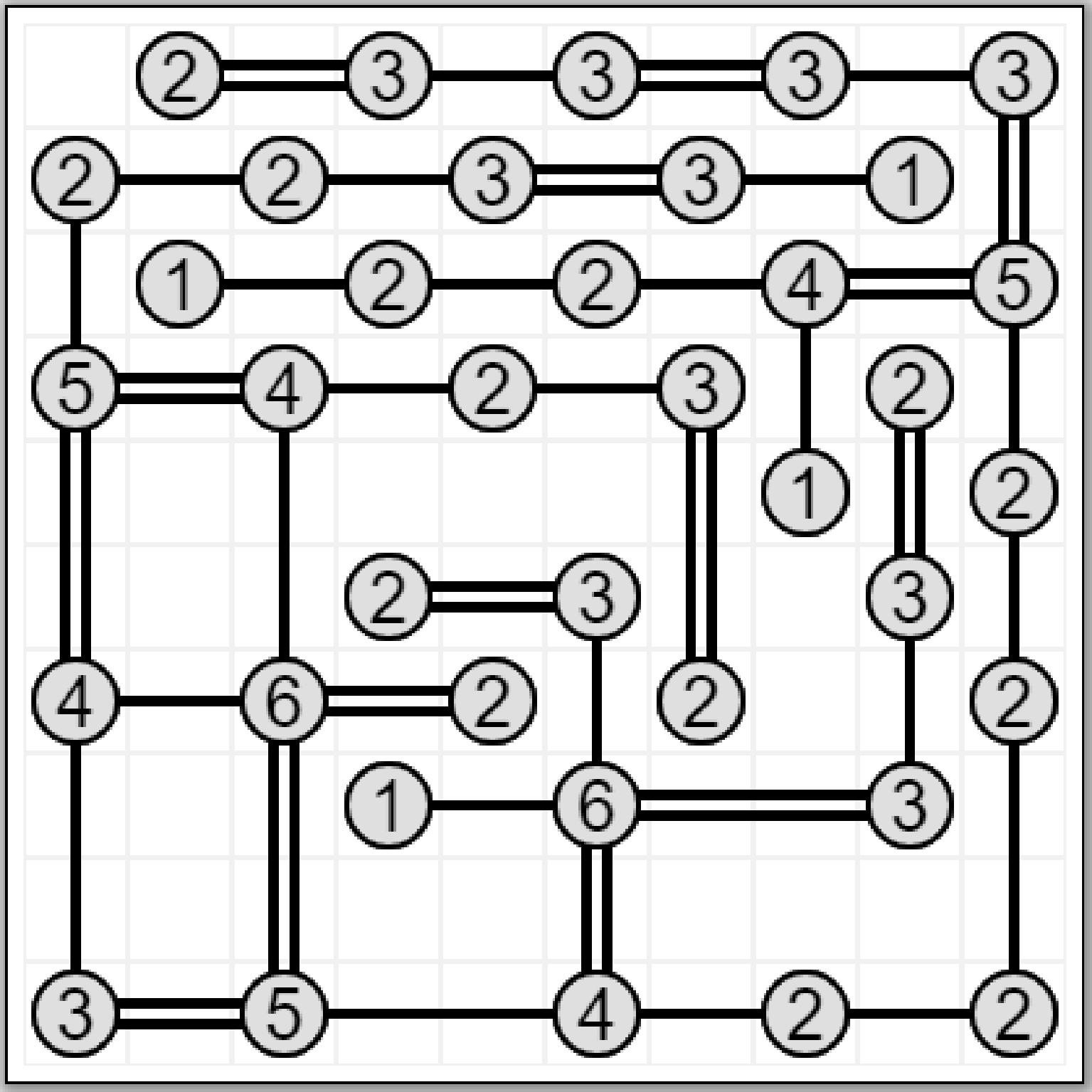

THE LITTLE GREEN SHOP

301 E. Layton Chelsea, OK.



Across From Harp's

918 - 789 - 3676



FISHING EQUIPMENT & SUPPLIES
MINNOWS * NIGHT CRAWLERS
SHRIMP * CHICKEN LIVER
CUT SHAD * RABBIT LIVER
WHOLE SHAD & MORE
DRINKS, SNACKS

Route 66 items for sale
6 POUND BAG OF ICE \$1.50
20 POUND BAG OF ICE \$3.75

A Good Community To Live In!

CHELSEA TERRACE

FOR MORE INFORMATION CONTACT OUR
Rental Office at (918) 789-5200
302 Charlotte Street, Chelsea, OK.

\$200.00 DEPOSIT

\$450 1 bedroom ~ \$500 2 bedroom
ground floor/ handicap accessible
washer/dryer hookup

Paid: water, sewer, garbage, & lawn care
Provided: refrigerator, stove

3 Bedroom House with One Car Garage
1101 square feet

\$590.00 monthly ~ \$350.00 deposit ~ washer/dryer hookups ~ Provided: refrigerator, stove

An Equal Housing Opportunity

SECTION 8 HOUSING VOUCHERS ACCEPTED

Community Links Of Chelsea

1100 Walnut

Chelsea, OK 74016

Ph: (918) 789-2862

Fax (918) 789-5296

Email:

commuitylinks1999@yahoo.com

Please give us feedback at:

<http://links.qitg.net>

Printing: Business Cards, Letterheads – Flat or raised print available. Brochures, Business Forms, and Personalized greeting cards.

Advertising: Links Newsletter, Bi-Monthly distributed by persons with developmental disabilities, Connecting Communities at an affordable rate.

Office Supplies: Self Inking Stamps, Paper products, Toner Cartridges, Printer Cartridges. If we don't have it in stock we will order for you. Most orders complete in 3 days

Western Wear * Boots * Tack * Laundry Drop

Langley

Western Store

20x
Cruel Girl
Lawman
Roper
American West

Ariat|Justin|Tony Lama|Lucchese|Minnetonka

HWY 82|Langley, Oklahomna

918-782-2726

Open 9:30 - 6:00 pm * Closed Sunday

langley_western_store@yahoo.com

P.O. Box 730

1116 N 3rd. street

Langley, OK 74350

**Reid's Discount Pharmacy
& Compounding Lab**



**206 S. Ash
Nowata, OK**



918-273-0433

Welcome to Mayes County!

For over 70 years, Mayes County Propane has been providing quality service to customers in Pryor, OK and the surrounding areas. We are the preferred propane supplier to residential, commercial and agricultural customers in our area.



**MAYES
COUNTY PROPANE**

4665 West Hwy 20 • Pryor, OK 74361

For propane services you can trust and rely on, contact Mayes County Propane today! We look forward to the opportunity to serve all of your propane needs.

Phone 918-825-2433
Toll Free 1-800-722-2669

www.propanemcp.com
propanemc@yahoo.com

compassionate about care.
PASSIONATE ABOUT LIFE.



GSH

GOOD SHEPHERD HOSPICE

Free Medicare Benefit

We believe that care during a terminal illness is more than just a diagnosis and treatment.

It's a daily exercise in making this moment, this day... the very best it can be.

918.786.6182

800.787.2226

www.goodshepherdhospices.com

CryptoQuote Puzzles Solution

Title: Justify Salary

There's no way I can justify my salary level, but I'm learning to live with it.

Quote From: Drew Carey

Title: Dumb Blonde

I'm not offended by all the dumb blonde jokes because I know I'm not dumb... and I also know that I'm not blonde.

Quote From: Dolly Parton

Title: Man's Character

Nearly all men can stand adversity, but if you want to test a man's character, give him power.

Quote From: Abraham Lincoln

DpTABLETALKERS

Home of The Mini Billboard

**Let's market your business
with mini billboards
on restaurant table tops.**

*Your color ad will be seen thousands of times
over a two year period.*

Check out the website: www.dptabletalkers.com
email: dptabletalkers@gmail.com Call or Text: 918-640-4286

We will be glad to help you with your marketing needs.



Word Search Puzzle Solution

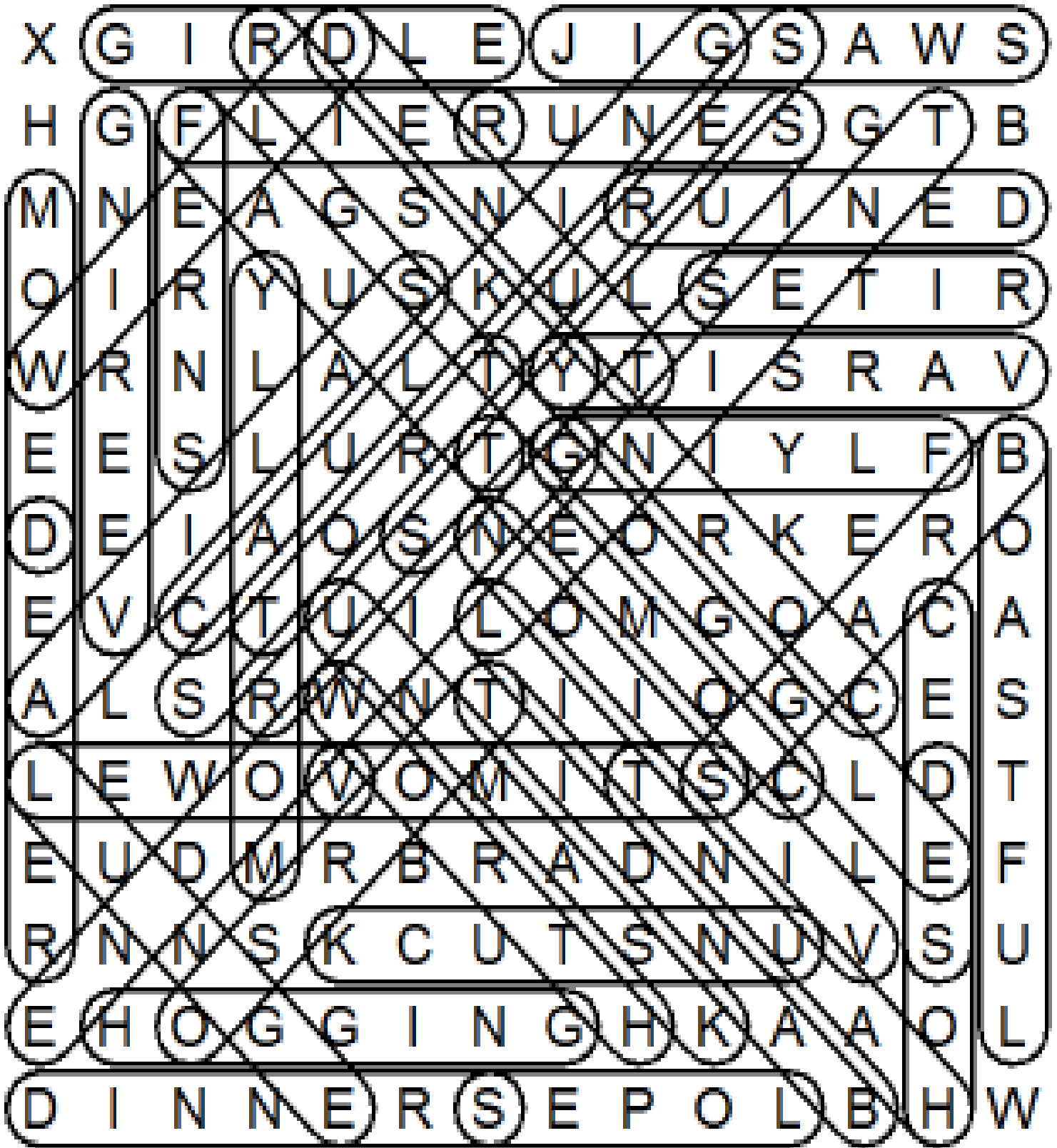

DATA MASTERS: Eric Peachey and Heather Conn

HERE TO HELP YOU GROW
a brighter financial future

 Lakeside State Bank

"Big enough to serve you, small enough to know you."



CHELSEA | 516 Walnut | 918.789.2581 | OOLOGAH | 6695 E. 400 Rd. | 918.443.2474 | www.lakesidebankok.com

Sudoku Puzzle Easy Solution

7	5	4	8	9	1	6	2	3
3	6	1	2	7	4	5	8	9
8	2	9	3	5	6	1	4	7
6	7	3	1	4	5	2	9	8
9	8	2	7	6	3	4	1	5
1	4	5	9	2	8	3	7	6
5	1	7	4	3	9	8	6	2
4	9	6	5	8	2	7	3	1
2	3	8	6	1	7	9	5	4

Sudoku Puzzle Moderate Solution

6	9	2	8	4	1	5	3	7
3	4	8	7	9	5	1	2	6
5	1	7	2	3	6	8	9	4
1	7	6	9	2	8	3	4	5
2	5	4	3	6	7	9	1	8
9	8	3	5	1	4	7	6	2
4	6	5	1	7	3	2	8	9
8	3	9	6	5	2	4	7	1
7	2	1	4	8	9	6	5	3

DATA MASTER: Nikki Hamilton

Crossword Puzzle Solution

1	2	3	4		5	6	7	8		9	10	11	12	13
N	A	M	U		S	H	I	H		A	D	E	E	R
14					15					16				
A	C	A	N		F	A	R	O		C	O	R	N	S
17				18						19				
P	H	Y	S	I	C	I	A	N		R	E	N	D	S
20						21			22					
A	T	O	A	D		G	E	C	K	O				
			23		24				25		26	27	28	29
			F	T	S				H	I	B	A	C	H
		30				31	32							
		R	E	A	C	T	I	O	N	A	R	I	E	S
33	34			35						36				
A	S	A		G	U	A	T			T	A	P	A	S
37			38		39			40	41		42			
M	A	N	A		M	O	O	L	A		T	H	R	U
43				44				45		46		47		
A	N	G	L	O				F	E	M	A		E	T
48					49	50				51				
S	T	E	P	H	E	N	F	O	S	T	E	R		
52										53				
S	A	S	H	I	M	I				O	W	S		
				54			55	56		57		58	59	60
				O	U	N	C	E		A	P	A	R	T
61	62	63	64			65			66					
B	U	R	M	A		E	A	S	Y	R	I	D	E	R
67						68					69			
E	L	T	O	N		R	I	T	A		E	R	I	E
70						71					72			
A	M	E	S	S		S	N	O	W		S	Y	N	S

DATA MASTERS: Eric Peachey and Heather Conn

**We would like to
thank the following
Businesses for
distributing LINKS**

Adair

Casey's General Store
Woodshed

Afton

Afton City Hall
Evans Roofing

Big Cabin

Big Cabin Senior Citizens

Chelsea

Bank of Commerce
Chelsea Family Pharmacy
Chelsea Library
Chelsea Post Office
Chelsea Sr. Citizens
Chelsea Terrace
Community Links
Dollar General
Harp's Grocery
Jiffy Mart
Lakeside State Bank
Little Green Shop
Main Street Diner

Chouteau

Cherry's Chouteau Mall
Chouteau Public Library &
Senior Citizens Center
Dutch Pantry
Marvin's Grocery
Pizza Corral

Claremore

Bill's Sporting Goods
Brook Field Nursing Home
Claremore DHS
Claremore Nursing Home
Claremore Senior Citizen's
Claremore Veteran's Center
Midco Clothes & More
Stillwater Milling
Emerald Care Center

Commerce

Eastwood Manor

Fairland

Fairland Sr. Citizen's

Grove

Eagles Landing
Drakes
Grand Prosthetics & Artificial
Limbs
Grandwood
Mr. M's Convenience Store
Grove Sr. Citizens
Harps Grocery
Tom Cat Corner

Jay

Sinclair Station
Delaware County Library
Jay Senior Citizen's

Ketchum

Buddy's Foods
Woodshed

Langley

4 State Insurance
Langley Drug
Reasor's Grocery Store
Langley Western Store

Miami

Marvin's Grocery
Windridge
Wal-Mart Supercenter

Nowata

D&L's
Homeland
Nowata Depot Café
Nowata Senior Citizens Cen-
ter
Ranch Supply
Reid's Discount Pharmacy

Oologah

Pump - N - Petes #15
Tacora Mart (Conoco)

Pryor

Innovations in Hair
Mayes Co. Nutritional Center
Wilkerson Real Estate
Pryor Library
Shady Rest Nursing Home
Paulie's Donuts
The Book Exchange

Spavinaw

T-General Store

Vinita

Burrough Manor
Carter's IGA
Grand Lake Mental Health
Heartsworth House
Midco Clothes & More
Sam's Tire
Veterans Clinic
Vinita Sr. Center
Vinita DHS
Vinita Post Office
Wood Shed
Young's Tire

Welch

Welch State Bank

White Oak

The Rancher Convenience/
Deli

Winganon

Winganon Bait Shop

Vinita Muffler & Radiator

Steven Smith - MD/DHT
"Over 90 years Experience"

**Fast, Professional Work
 the First Time!**

- Cat-Back Dual Exhaust
- Catalytic Converter Service
- Gas Tank Cleaned, Repaired, Lined & Coated
- Radiators - Plastic or Brass

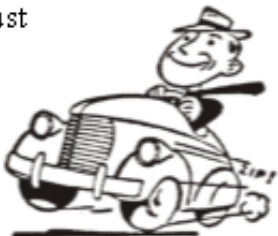

(918) 256-6969

**502 N. Wilson
 Vinita, OK 74301**

We can mail current or past issues to you for \$2.00 per issue. To receive every issue by mail we offer two subscriptions:
 6 months subscription for \$24.00
 Full year subscription for \$48.00

LINKS

Information

The Links Paper comes out twice a month, the 5th and the 20th of every month. We offer many different advertising options and have competitive pricing. Should you be interested in placing an ad with us you can contact us at the phone number or the email provided below.

Deadlines for ad submission:
 5th issue: 25th of previous month
 20th issue: 10th of the same month

**Community Links of Chelsea
 1100 Walnut
 Chelsea, OK 74016
 communitylinks1999@yahoo.com
 (918) 789-2862
 Open:
 Monday - Friday 8am to 4:00pm**



**Commercial * Residential * Industrial
 Service * Remodel * New Construction
 Licensed * Bonded * Insured**

**918-825-3000
 1204 SW 1st * Pryor, OK 74361**

BIBLE BOOKSTORE & BOOK EXCHANGE
 25 YEARS SERVING NORTHEAST OKLAHOMA

**CHRIS HARDY
 OWNER**

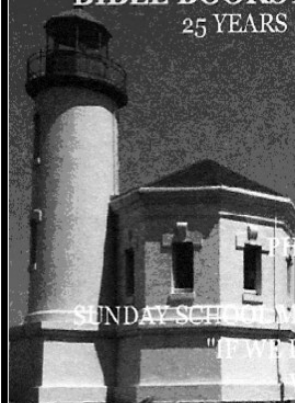

3 NORTH ADAIR ST.
 PRYOR CREEK, OKLAHOMA 74361
 PHONE 918 825 6015 FAX 918 825 6974
 BIBLES, NEW AND USED BOOKS
 SUNDAY SCHOOL MATERIALS, SOUNDTRACKS, MUSIC
 "IF WE DON'T HAVE IT, WE'LL ORDER IT!!!"
 WWW.PRYORBOOKEXCHANGE.COM

Contents of this newspaper is compiled from available original sources.

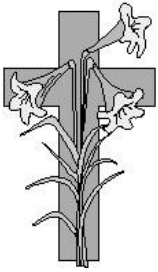

JEWELS FROM THE WORD

STUDY THE BIBLE Every year when school was out, the other kids could be found playing baseball, roller-skating, riding bikes, or swinging, but I was inside reading a book. I got my first library card when I was in the 3rd grade at 8 years old.

If you come to my home to visit, you will probably be amazed at all the books, magazines, and newspapers cluttering my home. Why is it that I have such difficulty discarding books? It all goes back to my mother who trained us children to value books. From the day a little cloth book was put in our baby hands, we were taught to love them. Don't tear the book. Don't scribble in the book. We love our books, don't we?

My school teachers influenced my love of books. At the beginning of the school year, when books were given out, I opened the first page to the label that showed who used the book the year before and proudly entered my name on the next line. If the book was new, we went through a procedure of breaking in the new book, by opening up to the middle and running our fingers down the middle, then opening to another place in the book and doing the same. We were taught to never open the book and bend it backward which would break the spine.

I can only think of a few times in my lifetime that I have actually

Lavon Hightower Lewis To read more devotional, go to:

<http://jewelsfromtheword.com/> Email me at llewis2138@sbcglobal.net

thrown a book in the trash. Most times it was because the book was badly damaged, but several times it was because it un-Biblical. How did I know? Because I know what the Bible says.

It is said that banks train tellers to recognize counterfeit bills by giving them the real bills to study. If you know what the real thing looks like, you should instantly know when something is counterfeit.

In 2 Timothy 2:15 NKJV Paul says, Be diligent to present yourself approved to God, a worker who does not need to be ashamed, rightly dividing the word of truth.

How do I know the truth? I study the Bible for myself.

DATA MASTER: Steven Burdick



- Auto & Truck Loans
- Home Loans
- Business Loans
- Checking, Savings & CD's
- All of your Banking Needs!

THE BANK OF COMMERCE

789-2567

..... *Your Bank in Chelsea.....*



MEMBER FDIC



EQUAL HOUSING

LENDER